

SYSTEM85

35 - 50 C85

RESIDENTIAL INTEGRATION

3KW KIT FOR SLATE ROOF

35x50C integrated roof mounting system - 3kW kit for slate roof
 Système (35à50C) intégré individuel Kit 3kw Toiture ardoise
 KIT 3kW Integración individual 35x50C con marco
 traditionelle Bedachungsanlage für polykristalline oder monokristalline
 Module mit Rahmen

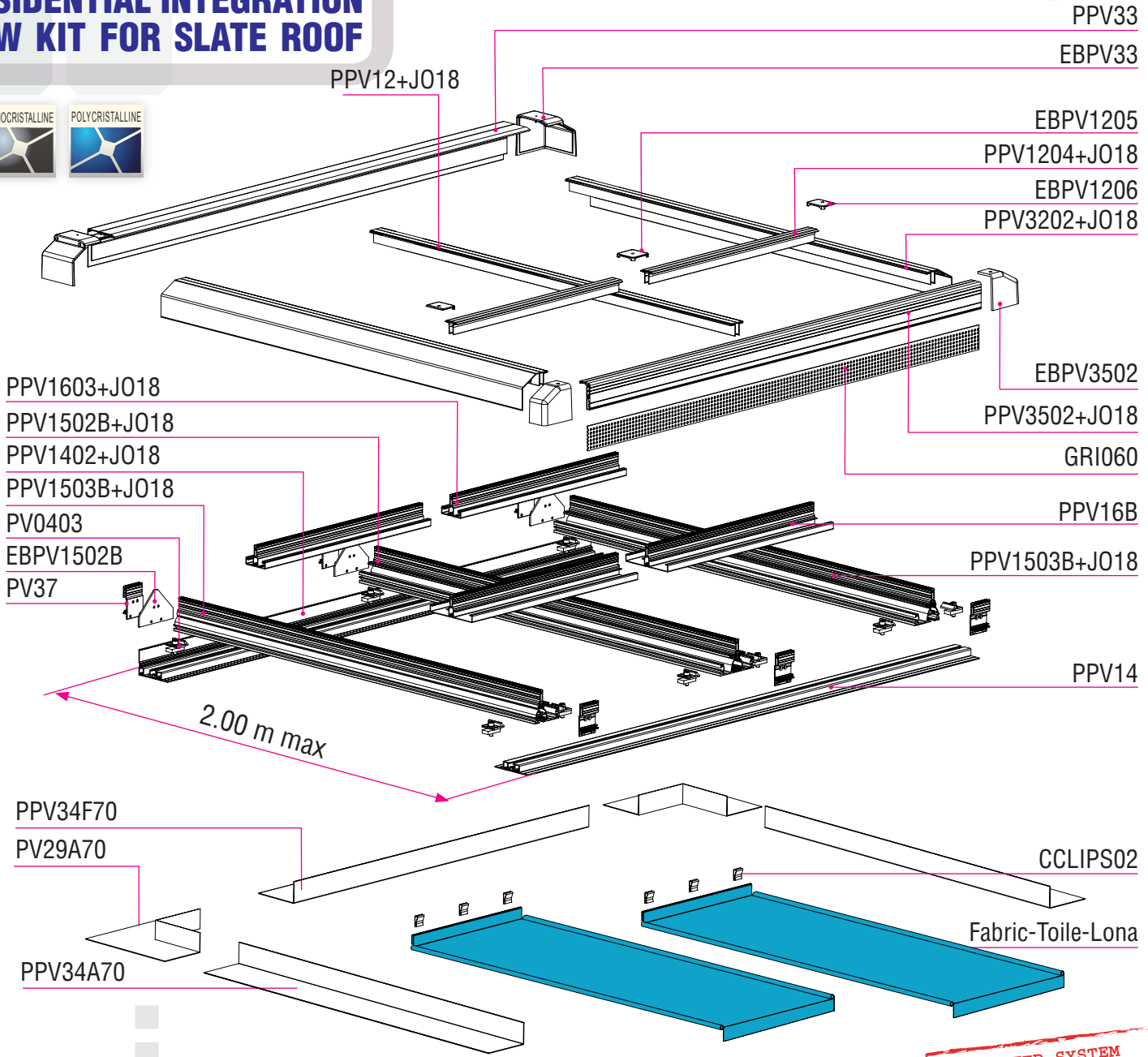

PATENTED SYSTEM
 SYSTÈME BREVETÉ
 SISTEMA PATENTADO
 N° P200930027

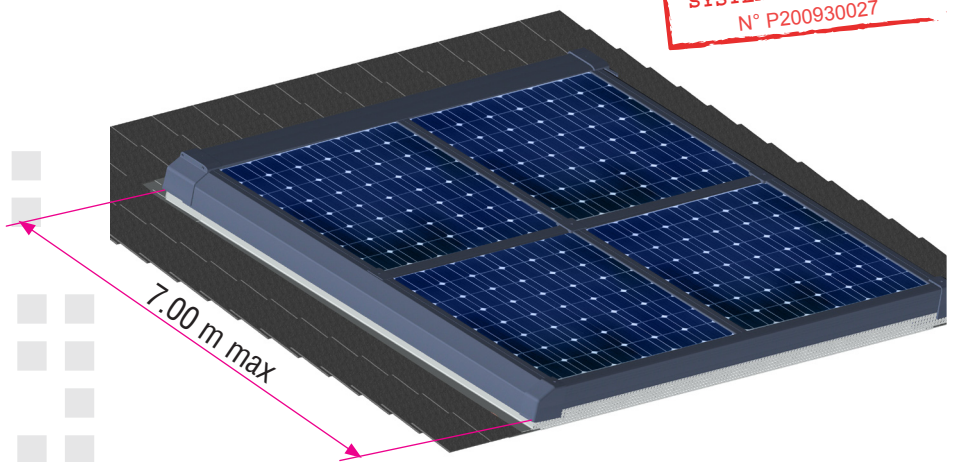
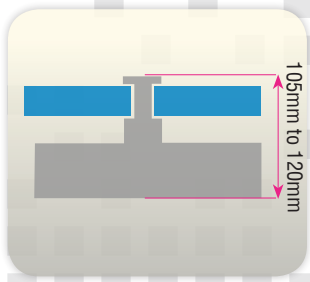

3kW KIT 85 Residential integration



35-50 C Integrated system 3kW KIT for slate roof

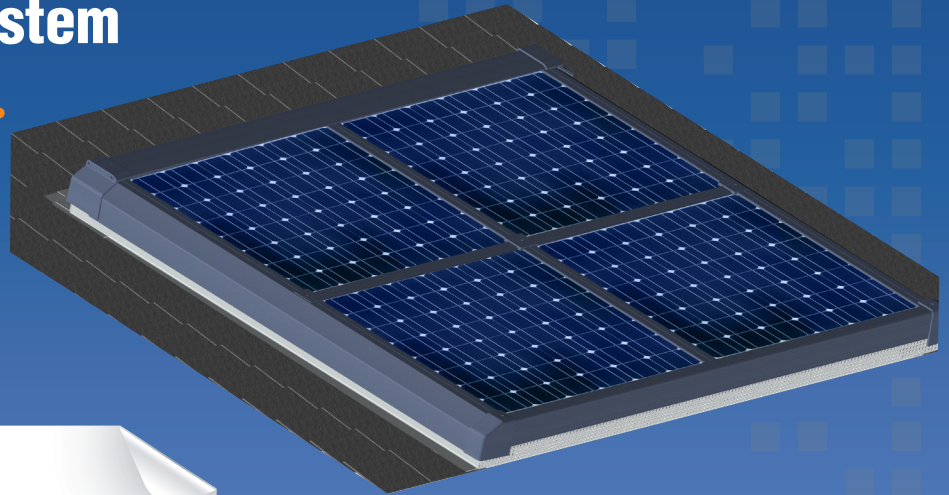

+ ADVANTAGES

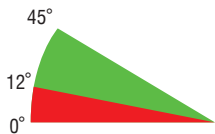

Tilt angle

- Quick installation
- Slate roof integration
- Aesthetic and design

For 35mm to 50mm thick panels



LANDSCAPE INSTALLATION
RECOMMENDED



FOR FRAMED PANELS

Structure components:

Aluminium profiles
Aluminium foundry pieces (AS13)
A2 stainless steel fastenings RAL 7016 +
EPDM washer and joint

Finish:

- mill finish
- powder coated with PTFE
textured finish RAL 7016

Intermodule rafter

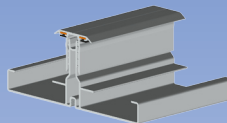

Support rail

Optional joint
(thermal break)

Rafter fixation
channel

82 mm fixing centres

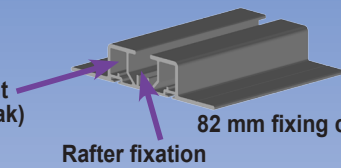

Connectors

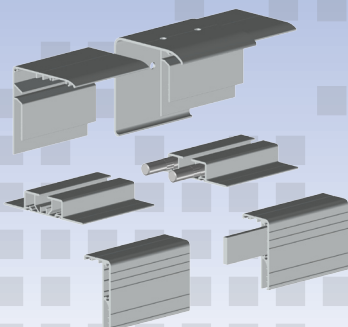

Side rafter

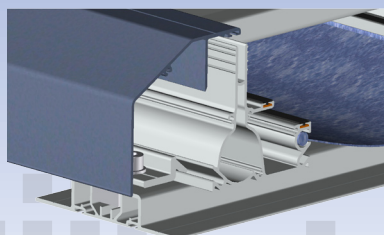

Central rafter

